



TRAK™ 60

POWER & EFFICIENCY

Input Power Options: 120v

Current at Max Speed: 1.16 Amps

Power: 0.13 hp

Maximum Speed: 8 mph

Maximum Affected Area: 20 ft. diameter / 400 sq. ft.

MODELS

76009

76010

76011

DIMENSIONS & WEIGHT

Fan Diameter: 60 inches

Fan Weight: 48 lbs

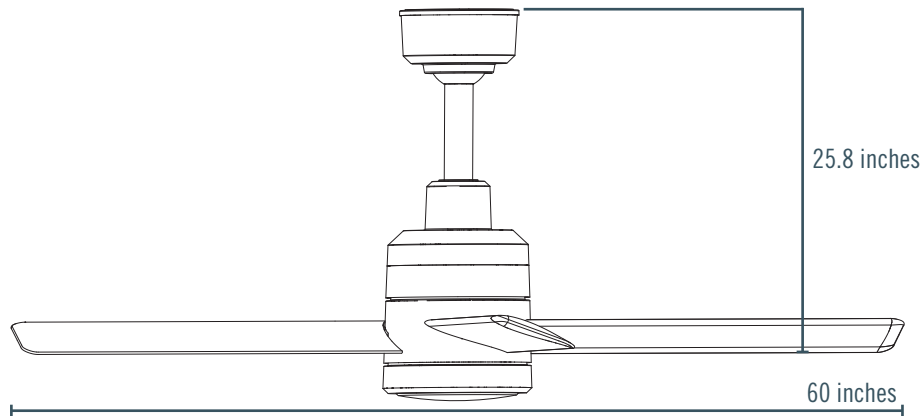

MOUNTING & SAFETY

Mounting Options: Standard / Angles

Downrod: 11" Down Rod

Safety Features:

INCLUDED IN THE BOX

included: Wall Control, 11" Down Rod

Optional: Handheld Control

Down Rod Sizes: 24", 36", 48", 60", 72"

WARRANTY & CERTIFICATIONS

Certifications: ETL/Intertek-certified to ANSI/UL 506 and CSA C22.2 No. 113 in North America

Indoor/Outdoor/Damp Rating: IP44

Warranty¹: 3-Year Warranty on Parts